

CMS100N04D2-HF

**N-Channel
RoHS Device
Halogen Free**

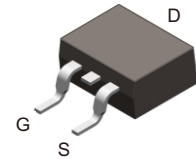

Features

- Super low $R_{DS(on)}$ and gate charge.
- Advanced shielded-gate technology.
- Green device available.

Mechanical data

- Case: TO-263, molded plastic.
- Molding compound: UL flammability classification rating 94V-0.
- Terminals: Matte tin-plated leads, solderability per MIL-STD-202, method 208.

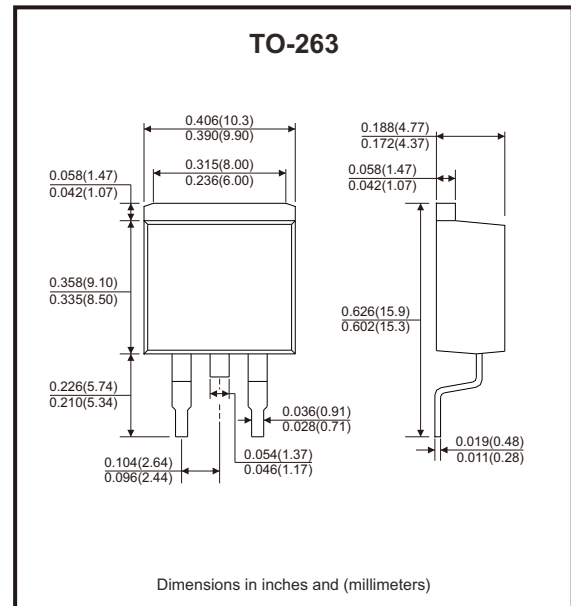

Circuit Diagram

- G : Gate
- S : Source
- D : Drain

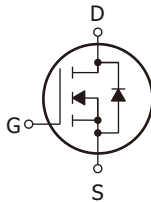

Maximum Ratings (at $T_A=25^\circ\text{C}$ unless otherwise noted)

Parameter	Symbol	Value	Unit
Drain-source voltage	V_{DSS}	40	V
Gate-source voltage	V_{GSS}	± 20	V
Continuous drain current (package limit) $T_c=25^\circ\text{C}$ (Note 1)	I_D	100	A
Continuous drain current (silicon limit) $T_c=25^\circ\text{C}$ (Note 1)	I_D	220	
Continuous drain current (silicon limit) $T_c=100^\circ\text{C}$ (Note 1)	I_D	140	
Pulsed drain current ($t_p < 10\mu\text{s}$)	I_{DM}	880	A
Single pulse avalanche energy (Note 3)	E_{AS}	65	mJ
Power dissipation ($T_c=25^\circ\text{C}$)	P_D	156	W
Thermal resistance junction to case (Note 1)	$R_{\theta JC}$	0.8	$^\circ\text{C/W}$
Thermal resistance junction to air	$R_{\theta JA}$	50	$^\circ\text{C/W}$
Operating junction temperature range	T_J	-55 to +150	$^\circ\text{C}$
Storage temperature range	T_{STG}	-55 to +150	$^\circ\text{C}$

Electrical Characteristics (at T_A=25°C unless otherwise noted)

Parameter	Symbol	Conditions	Min	Typ	Max	Unit
Static Characteristics						
Drain-source breakdown voltage	V _{DSS}	V _{GS} = 0V, I _D = 250μA	40			V
Zero gate voltage drain current	I _{DSS}	V _{DS} = 40V, V _{GS} = 0V			1	μA
Gate-body leakage current	I _{GSS}	V _{GS} = ±20V, V _{DS} = 0V			±100	nA
On Characteristics						
Static drain-source on-resistance (Note 2)	R _{DS(on)}	V _{GS} = 10V, I _D = 20A		1.7	2	mΩ
	R _{DS(on)}	V _{GS} = 4.5V, I _D = 20A		2.0	2.4	mΩ
Gate threshold voltage	V _{GS(th)}	V _{DS} = V _{GS} , I _D = 250μA	1	1.5	2.5	V
Dynamic Characteristics						
Input capacitance	C _{iss}	V _{GS} = 0V, V _{DS} = 20V, f = 150kHz		6269		pF
Output capacitance	C _{oss}			2818		
Reverse transfer capacitance	C _{rss}			222		
Total gate charge	Q _g	V _{DD} = 20V, V _{GS} = 10V, I _D = 100A		112		nC
Gate to source charge	Q _{gs}			21		
Gate to drain (miller) charge	Q _{gd}			14.6		
Switching Characteristics						
Turn-on delay time	t _{d(on)}	V _{DD} = 20V, V _{GS} = 4.5V R _G = 3Ω, I _D = 20A		24		ns
Turn-on rise time	t _r			84		
Turn-off delay time	t _{d(off)}			62		
Turn-off fall time	t _f			20		
Source-Drain Diode Characteristics						
Diode forward voltage (Note 2)	V _{SD}	I _{SD} = 50A, V _{GS} = 0V			1.2	V
Reverse recovery time	t _{rr}	I _F = 20A, V _R = 30V, di/dt = 100A/μs		152		ns
Reverse recovery charge	Q _{rr}				375	

- Notes: 1. The data tested by surface mounted on a 1 inch² FR-4 board with 2OZ copper.
 2. The data tested by pulsed, pulse width ≤ 300μs, duty cycle ≤ 2%.
 3. The EAS data shows Max. rating. The test condition is V_{DD}=30V, V_{GS}=10V, L=0.1mH.
 4. The data is theoretically the same as I_D and I_{DM}, in real applications, should be limited by total power dissipation.

Rating and Characteristic Curves (CMS100N04D2-HF)

Fig.1 - Output Characteristics

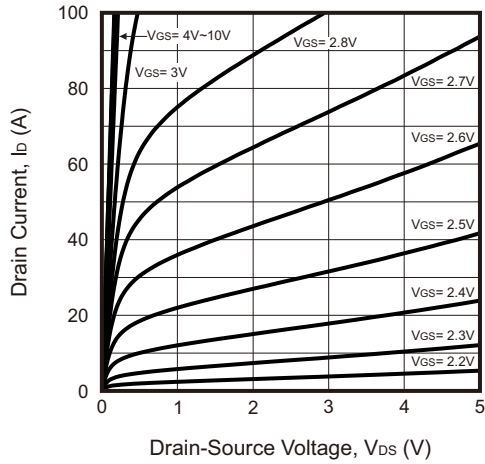

Fig.2 - On-Resistance vs. Drain Current and Gate Voltage

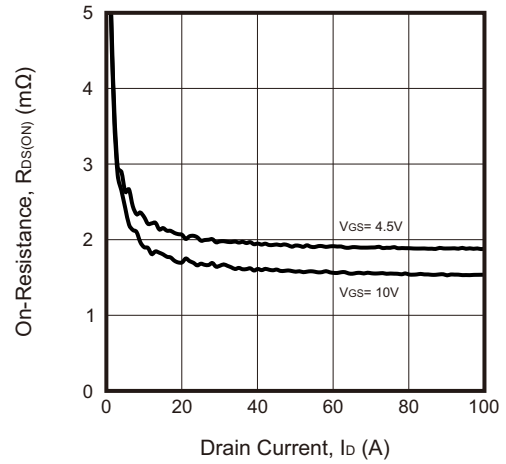

Fig.3 - On-Resistance vs. Gate-Source Voltage

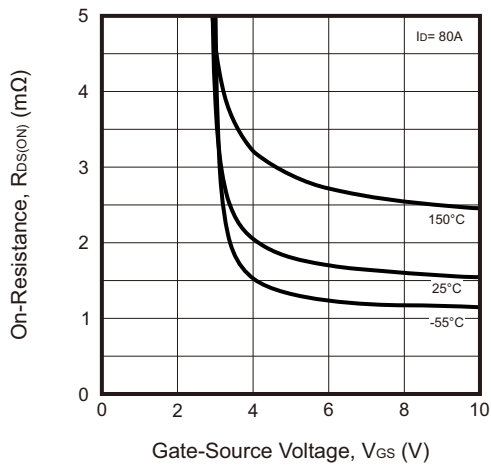

Fig.4 - Body-Diode Characteristics

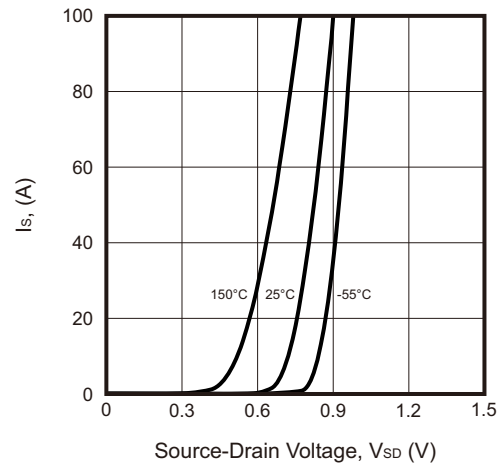

Fig.5 - On-Resistance vs. Junction Temperature

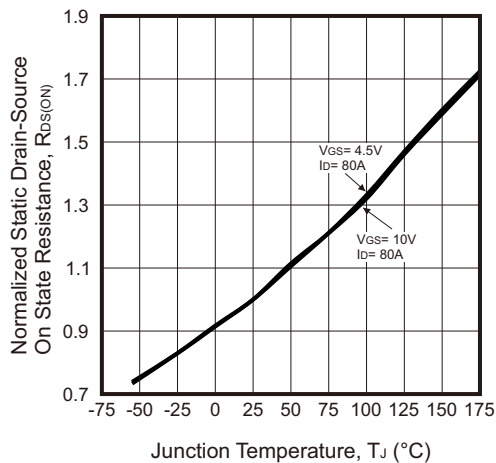
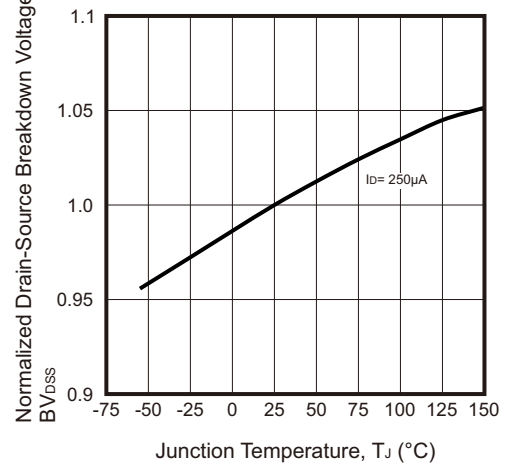

Fig.6 - Drain Source vs. Junction Temperature



Rating and Characteristic Curves (CMS100N04D2-HF)

Fig.7 - Capacitance Characteristics

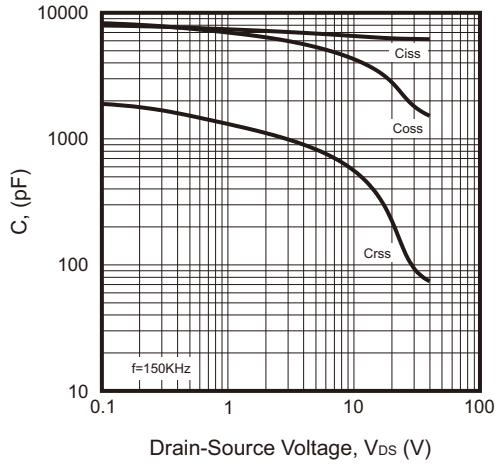

Fig.8 - Gate Voltage vs. Junction Temperature

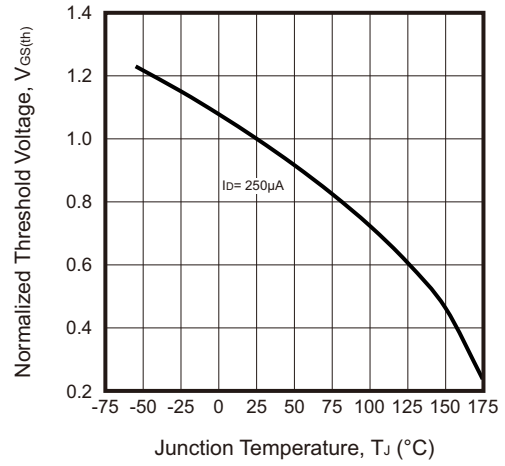

Fig.9 - Transfer Characteristics

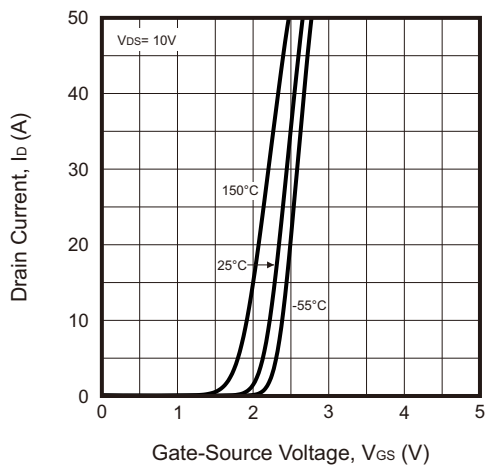
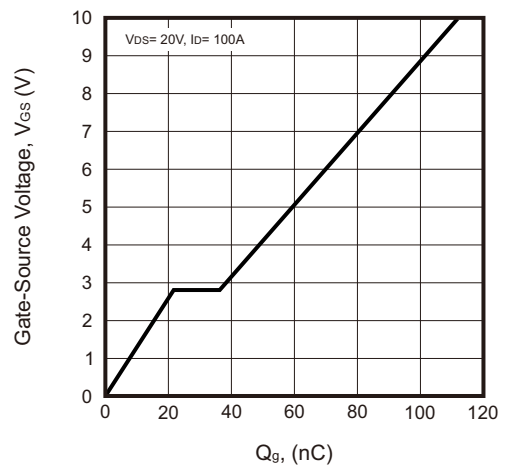
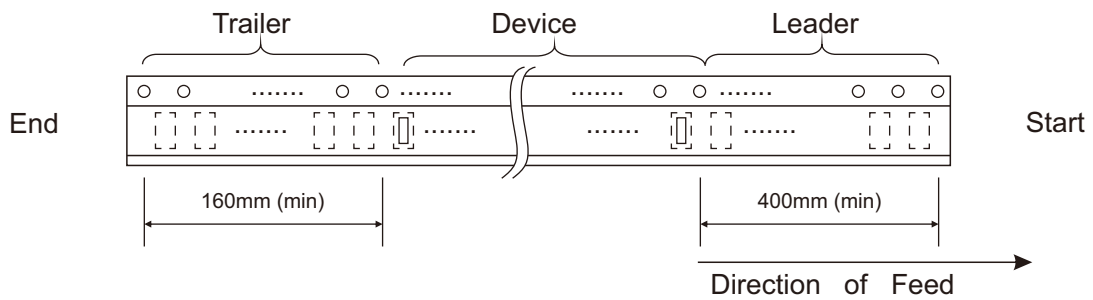
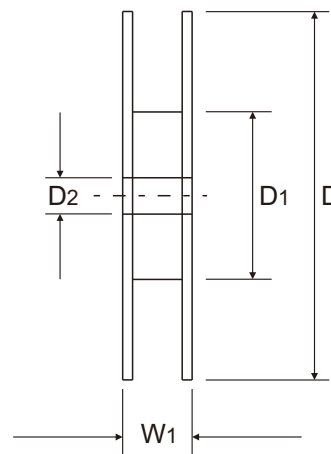
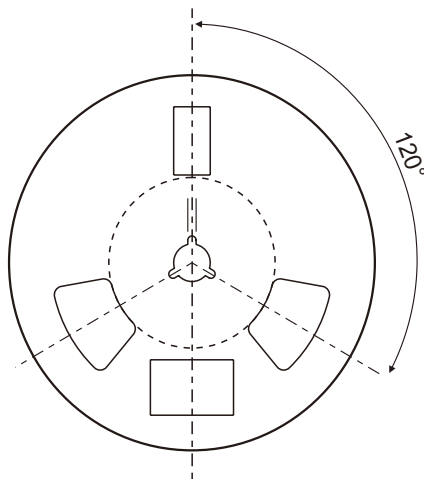
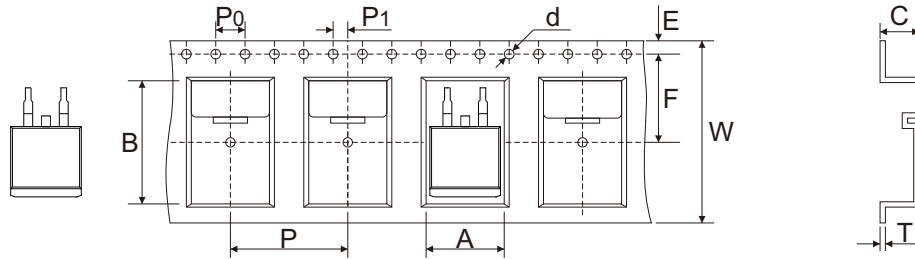

Fig.10 - Gate-Charge Characteristics



Reel Taping Specification



TO-263	SYMBOL	A	B	C	d	D	D1	D2
	(mm)	10.80 ± 0.10	16.13 ± 0.10	5.21 ± 0.10	1.55 ± 0.05	330 ± 0.20	100 ± 0.20	13.00 ± 0.20
	(inch)	0.425 ± 0.004	0.635 ± 0.004	0.205 ± 0.004	0.061 ± 0.002	12.992 ± 0.008	3.937 ± 0.008	0.512 ± 0.008

TO-263	SYMBOL	E	F	P	P0	P1	T	W	W1
	(mm)	1.75 ± 0.10	11.50 ± 0.10	16.00 ± 0.10	4.00 ± 0.10	2.00 ± 0.10	0.35 ± 0.03	24.00 + 0.30 - 0.10	24.00 ± 0.20
	(inch)	0.069 ± 0.004	0.453 ± 0.004	0.630 ± 0.004	0.157 ± 0.004	0.079 ± 0.004	0.014 ± 0.001	0.945 + 0.012 - 0.004	0.945 ± 0.008

Marking Code

Part Number	Marking Code
CMS100N04D2-HF	020N04TB

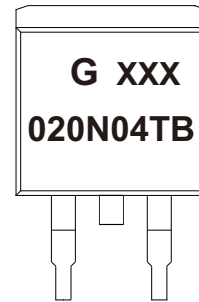

XXX = Control code

Suggested P.C.B. PAD Layout

SIZE	TO-263	
	(mm)	(inch)
A	2.08	0.110
B	3.50	0.138
C	8.80	0.346
D	9.00	0.354
E	10.4	0.409
F	2.30	0.091
G	2.54	0.100
H	4.00	0.157
I	16.5	0.650

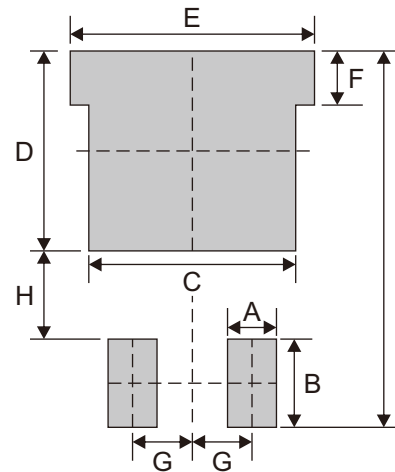

Standard Packaging

Case Type	REEL PACK	
	REEL (pcs)	Reel Size (inch)
TO-263	800	13